

contents

fresnel spots	04
zoom-ellipsoid-spot	06
slim lights	07
diffusion screens	08
materials	11
space lights	12
space light maxi light	14
pen lights	14
shooting table	14
compact stands	15
universal stands	17
ceiling systems	18
curtain tracks	26
time masters	26

validity: 2018-02-01
ex warehouse
plus tax rate
subject to alterations
without notice

STUDIO-SERVICE BACHT GMBH
Liebigstraße 26
D-45145 Essen
Fon +49 201 730097
Fax +49 201 708091
www.bacht.net
info@bacht.net

Item	Definition	Unit	Euro
------	------------	------	------

fresnel-spots ssp 80/3000/6000

ssp 80

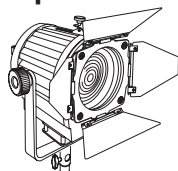

fresnel spot with fresnel lens, 80 mm diam
2000 J, adaptation independent of system

pc

1680.00

ssp 81

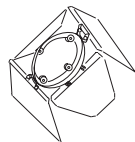

4 shutter attachment for fresnel spot
with Fresnel lens ssp 80

pc

115.00

ssp 82



fresnel lens, clear, for fresnel spot ssp 80

pc

68.00

ssp 85

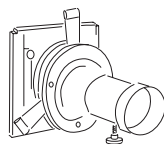

projection attachment for ssp 80, revolving
incl. 85 mm objective, 1 set shutter (4 pcs)

pc

645.00

ssp 87



iris diaphragm for ssp 85

pc

98.00

ssp 158



mask holder for ssp 85

pc

32.00

ssp xxx-xxx

mask for ssp 80/85 spot

pc

24.75

Item	Definition	Unit	Euro
ssp 88-d	dia holder for ssp 85	pc	55.00
			
ssp 80/1	flash tube, 2,000 J, spare part for ssp 80	pc	365.00
ssp 80/2	pilot lamp, 300 W halogen, 230 V frosted, spare part for ssp 80	pc	14.50
ssp 80/3	pilot lamp, 300 W halogen, 120 V frosted, spare part for ssp 80	pc	14.50
ssp 3000	focus adjustable fresnel spot loadable up to 3,200 J adaptation independent of system	pc	2830.00
			
ssp 6000	focus adjustable fresnel spot loadable up to 6,400 J adaptation independent of system	pc	3210.00
			
ssp 3001	revolving 4 shutter attachment for ssp 3000	pc	140.00
			
ssp 3002	filter frame for ssp 3000	pc	55.00
ssp 6001	revolving 4 shutter attachment for ssp 6000	pc	165.00
			
ssp 6002	filter frame for Spot ssp 6000	pc	65.00

Item	Definition	Unit	Euro
------	------------	------	------

zoom-ellipsoid-spot esp 600

esp 600

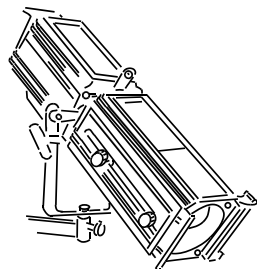

zoom-ellipsoid-spot 6,400 J, incl.
turning mechanism, filter support
2 hole diaphragms included
adaptation independent of system

pc

EOL

esp 605

turning mechanism for esp 600
housing/shutter unit (mounted by manufacturer)

pc

735.00

esp 601

mask support for esp 600/550

pc

118.00

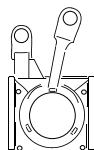

esp 604

iris diaphragm, microsectioned,
for esp 550/600

pc

245.00

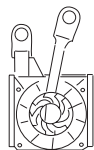

esp xxx-xxx

mask for zoom-ellipsoid-spot
esp 550/560/600

pc

32.75

esp 600/1

quartz flash tube, 6,400 J
spare part for esp 600

pc

680.00

esp 600/2

pilot lamp, 650 W halogen, 240-250 V
spare part for esp 600/550/1000/500

pc

21.00

esp 600/8

filter holder for esp 600, 165 x 165 mm

pc

26.00

Item	Definition	Unit	Euro
------	------------	------	------

slim lights

stl 069

Slim light, 69 cm white, 3,200 J
2 fans, 200 W halogen pilot light,
adaptation independent of system

pc 1980.00

stl 130

Slim light, 130 cm white, 2x 3,200 J
2 fans, 2x 200 W halogen pilot light
adaptation independent of system

pc 2960.00

stl 190

Slim light 194 cm white, 3x 3,200 J
2 fans, 3x 200 W halogen pilot light,
adaptation independent of system

pc 3980.00

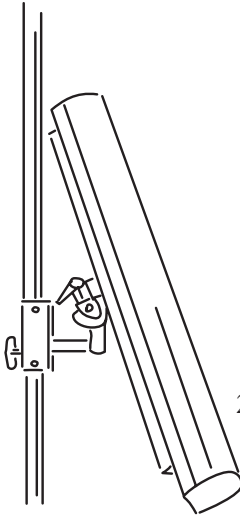

accessories for slim lights

stl 130/3

Flash tube with central electrode, 6,400 J
spare part for slim lights

pc 425.00

stl 0691

Covering hood 69 cm, white

pc 255.00

stl 0692

Covering hood 69 cm, clear
spare part for slim light stl 069

pc 255.00

stl 131

Covering hood 130 cm, white
spare part for slim light stl 130

pc 295.00

stl 132

Covering hood 130 cm, clear
spare part for slim light stl 130

pc 295.00

stl 191

Covering hood 194 cm, white
spare part for slim light stl 190

pc 335.00

stl 192

Covering hood 194 cm, clear
spare part for slim light stl 190

pc 335.00

stl 0695

Barn door 79 x 16 cm,
bracket (pair) included

pc 365.00

stl 135

Barn door 140 x 16 cm,
bracket (pair) included

pc 425.00

stl 195

Barn door 200 x 16 cm,
bracket (pair) included

pc 515.00

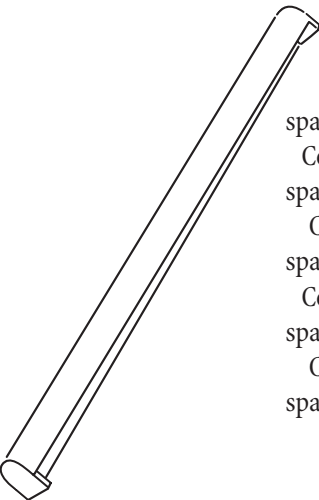

Item	Definition	Unit	Euro
diffusion screens			
se 3001	Aluminium profile for diffusion screen extralight construction	m	37.00
se 3005	connector, for SE 3001, (4 pcs necessary)	pc	6.00
se 3008	stand mount for SE 3001, incl. inclining jointset	pc	215.00
se 3025	border for diffusion screen made out of velcro, ready sewed for SE 3001	m	18.40
se 3005-q	plug-in connector inside the corner, aluminium, for pluggable diffusion screens se 3001, (4 pieces required)	pc	48.00
se 3010-q	longitudinal connector, aluminium, for pluggable diffusion screen se 3001	pc	62.00
se 3-080120 s	diffusion screen 80 x 120 cm with inclining joint and stand mount	pc	365.00
se 3-100150 s	diffusion screen 100 x 150 cm with inclining joint and stand mount	pc	410.00
se 3-120180 s	diffusion screen 120 x 180 cm with inclining joint and stand mount	pc	455.00
se 3-080120 t	diffusor for diffusion screen 80 x 120 cm	pc	120.00
se 3-100150 t	diffusor for diffusion screen 100 x 150 cm	pc	150.00
se 3-120180 t	diffusor for diffusion screen 120 x 180 cm	pc	180.00
se 6001-q	aluminium profile for pluggable diffusion screens, medium construction	m	64.00
se 6005-q	plug-in connector inside the corner, aluminium, for pluggable diffusion screen se 6001-q, set with 4 pieces	pc	295.00
se 6010-q	longitudinal connector, aluminium, for pluggable diffusion screen se 6001-q	pc	84.00

Item	Definition	Unit	Euro
se 4001	aluminium profile for diffusion screen light construction	m	42.00
se 4005	connector, inside for se 4001, incl. adaptation to profile, screws and washers (4 pcs)	set	375.00
se 4008	ring suspension M8 for SE 4001, incl. adaptation. to profile, screw and washer (4 pcs)	set	98.00
se 4025	border for diffusion screen made out of artificial leather and velcro, ready sewed for SE 4001	m	36.00
se 6001	aluminium profile for diffusion screen medium construction	m	64.00
se 6005	connector inside for SE 6001, incl. adaptation to profile, screws and washers (4 pcs)	set	425.00
se 6008	ring suspension M8 for SE 6001, incl. adaptation to profile, screw and washer (4 pcs)	set	98.00
se 6025	border for diffusion screen made out of artificial leather and velcro, ready sewed for SE 6001	m	48.00
se 6008-sp	stand mount for se 6001 including inclining joint set	pc	275.00
se 8001	aluminium profile for diffusion screen heavy construction	m	86.00
se 8005	connector inside for SE 8001, incl. adaptation to profile, screws and washers	set	480.00
se 8008	ring suspension for SE 8001, incl. adaptation to profile, screw and washer (4 pcs)	set	110.00
se 8010	longitudinal connector for diffusion screen profile SE 8001 for over 6 m length incl. adaptation to profile and screws	pc	175.00

Item	Definition	Unit	Euro
se 8025	border for diffusion screen made out of artificial leather and velcro , ready sewed for SE 8001	m	54.00
se 8008-sp	stand mount for se 8001 + se 9001 including inclining jointset	pc	525.00
se 9001	aluminium profile for diffusion screen heavy construction	m	89.00
se 9005	Connector inside for SE 9001, incl. adaptation to profile, screws and washers	set	595.00
se 9008	ring suspension for SE 9001, incl. adaptation to profile, screw and washer (4 pcs)	set	115.00
se 9010	longitudinal connector for diffusion screen profile SE 9001 for over 6 m lenght incl. adaptation to profile and screws	pc	175.00
se 9025	border for diffusion screen made out of artificial leather and velcro, ready sewed for SE 9001	m	62.00
se 9015	moveable beam, telescopic with 4ball bearing rubber castors, surface matted black plastic coated.	pc	635.00

Item	Definition	Unit	Euro
reflection and diffusion materials			
se 1030	cotton material, white, bleached 3.10 m width approx.	m	34.00
se 1060	cotton material, white, bleached 6 m width approx	m	78.00
se 1099	cotton material, white, bleached 10 m width approx	m	195.00
se 2030	reflection / diffusion material TREVIRA CS white 3 m width approx	m	48.00
se 2050	5 m width approx	m	75.00
se 2060	6 m width approx	m	88.00
te 2044	diffusion material Nylon white 65 g/qm, 150 cm width	m	00.00
se 2032	diffusion material TREVIRA CS white 80 g/m ² , 3 m width approx	m	00.00
se 2035	diffusion material, white, 200 g/sqm, width approx. 3 m	m	52.00
se 2052	diffusion material TREVIRA CS white 80 g/m ² , 5 m width approx	m	72.00
se 2052-pes	diffusion material, white, coated, 280 g/sqm, width approx. 5 m	m	85.00

Item	Definition	Unit	Euro
space lights / strip lights			
fl 3040/R	space light 30 x 40 x 20 cm, rimless, 3,200 J with inclining joint adaptation independent of system	pc	1830.00
fl 6040	space light 60 x 40 x 20 cm, 3,200 J with inclining joint adaptation independent of system	pc	2330.00
fl 6040/R	space light 60 x 40 x 20 cm, rimless, 3,200 J with inclining joint adaptation independent of system	pc	2560.00
fl 6080	space light 80 x 60 x 20 cm, 6,400 J with aluminium-U-mount adaptation independent of system	pc	4250.00
fl 12080	space light 120 x 80 x 30 cm, 2 x 6,400 J adaptation independent of system	pc	5800.00
fl 20120	space light 20 x 120 x 20 cm, 3,200 J with inclining joint adaptation independent of system	pc	2550.00
fl 20180	space light 20 x 180 x 20 cm, 4,000 J with inclining joint adaptation independent of system	pc	3480.00

Item	Definition	Unit	Euro
accessories for space lights / strip lights			
fl 123	barn door 65 x 20 cm for space light fl 6040	pc	125.00
fl 124	barn door 85 x 20 cm for space light fl 8060	pc	140.00
fl 125	barn door 125 x 30 cm for space light fl 12080	pc	175.00
fl 126	barn door 125 x 20 cm for space light fl 20120	pc	155.00
fl 127	barn door 185 x 20 cm for space light fl 20180	pc	185.00
fl 140	extension for fl-support, extension tube 35 diam. x 470 mm and counterweight 5 kg included	set	130.00
fl 141	extension for fl-support, extension tube 35 diam. x 470 mm and counterweight 8 kg included	set	145.00
fl 20/3	quartz flash tube with central electrode, 4000 J spare part for space light	pc	345.00
fl 20/2	pilot lamp, 150 W halogen, 42 V	pc	13.75
fl 20/4	Pilot lamp 70 W, 230 V, socket Ba15d spare part for space light	pc	9.60
fl 20/5	pilot lamp 100W, 230 V, socket Ba15d spare part for space light	pc	9.60
fl 20/6	pilot lamp 150W, 230 V, socket Ba15d spare part for space light	pc	9.60
fl 20/7	pilot lamp 205 W, 230 V, socket Ba15d spare part for space light	pc	9.60

Item	Definition	Unit	Euro
space lights Maxi light			
fl 300150	space light 300 x 150 x 60 cm, incl. 3 light modules 3,200 J each, adaption independent of system	pc	5350.00
fl 400150	space light 400 x 150 x 60 cm, incl. 4 light modules 3,200 J each, adaption independent of system	pc	6950.00
lm 150	light modul for maxi light 150 cm width, 3,200 J, 750 W halogen pilot light	pc	1080.00
fl 310	plexiglas diffusor for maxi light fl 300150 incl. suspension	pc	on request

pen lights

ls 200	light pen, 2000 J, adaption independent of system	pc	1150.00
ls 300	light pen, 3200 J, adaption independent of system	pc	1280.00

shooting table

at 160110	shooting table 160 x 110 x 70 cm Plexiglass plate 220 x 110 x 0.3 cm one side with a matt finish	pc	1560.00
------------------	--	----	---------

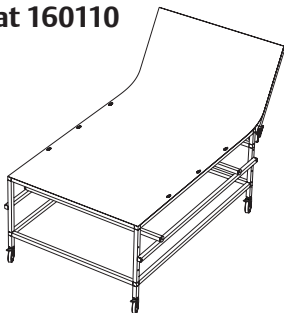

Item	Definition	Unit	Euro
compact lamp stands			
klS 200-20	compact lamp stand with solid steel footing and 4 ball bearing rubber castors, height 2 m boom 20 cm	pc	595.00
klS 200-30	compact lamp stand with solid steel footing and 4 ball bearing rubber castors, height 2 m boom 30 cm	pc	595.00
klS 300-20	compact lamp stand with solid steel footing and 4 ball bearing rubber castors, height 3 m boom 20 cm	pc	660.00
klS 300-30	compact lamp stand with solid steel footing and 4 ball bearing rubber castors, height 3 m boom 30 cm	pc	660.00
klS 201	lamp adaptor, 28 mm diameter x M 10		
klS 202	lamp adaptor, 28 mm diameter x 3/8"		
klS 203	lamp adaptor, 28 mm diameter x 5/8" socket pin	pc	32.50
klS 252	right angled adaptor 28 mm diam. with 3/8" socket pin	pc	95.00
klS 205	generator platform for compact lamp stand klS 200/250/300	pc	85.00

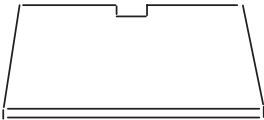
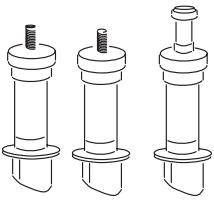
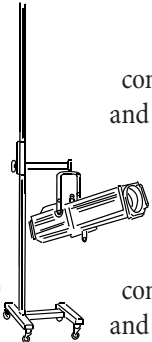
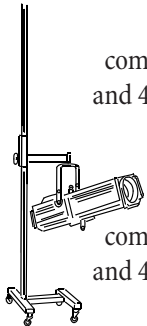

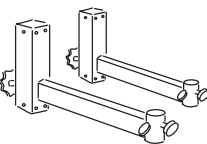
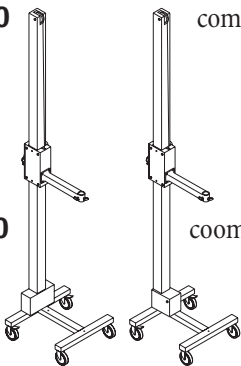
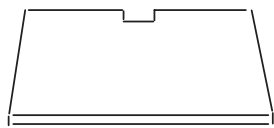
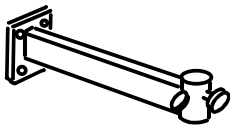
Item	Definition	Unit	Euro
klS 206	 <p>stand runner for stands klS 200/300 boom 30 cm included</p>		
klS 207		stand runner for stands klS 200/300 boom 20 cm included	pc
klS 208	extension tube 110 cm, plug in for klS stand boom	pc	138.00
klS 400	 <p>compact lamp stand with weight balance up to 10 kg, with solid steel footing and 4 ball bearing rubber castors, height 2.25 m</p>	pc	1450.00
klS 450		compact lamp stand with weight balance up to 18 kg, with solid steel footing and 4 ball bearing rubber castors, height 2.25 m	pc
klS 405	 <p>generator platform for compact stand klS 400</p>	pc	85.00
klS 455		generator platform for compact stand klS 450	pc
klS 406	 <p>lamp boom 30 cm, for compact stand klS 400/450</p>		
klS 407		lamp boom 20 cm, for column stand klS 400/450	pc

universal lamp stands

ulm 102

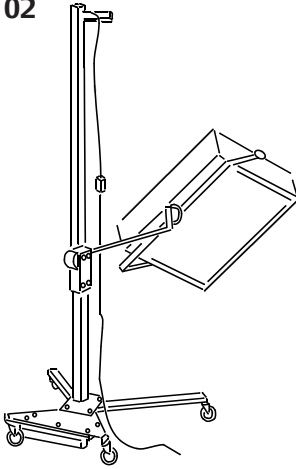

universal lamp stand
 electrically powered with motor
 drive and remote control cable
 height: up to 360 cm

pc 3150.00

la 110



lamp boom, 130 cm

pc 155.00

la 111



lamp boom, 65 cm

pc 35.00

zg 115

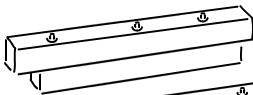

supplementary weight 14 kg for
 lamp stand ULG 101/ULM 102

pc 125.00

zg 116

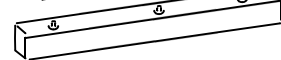

supplementary weight 25 kg for
 lamp stand ULG 101/ULM 102

pc 225.00

aub 112

aluminium-U-mount for Windowlight 10
 including accessories

pc 335.00

aub 113

aluminium-U-mount for Windowlight 15

pc 365.30

aub 114

aluminium-U-mount for Windowlight 20

pc 395.00

ds 112

pivot, 130 mm diameter

pc 380.00

Item	Definition	Unit	Euro
------	------------	------	------

EXPERT CEILING TRACK SYSTEM

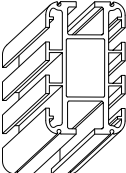
te 2006-2 te 2008-2		Expert-ceiling rail standard length 6m, weight 4.7 kg/m aluminium bright drawn	m	58.00
		black anodized	m	68.00

te 2005	Expert-arc radius and arclength according to specification 2 rail connections additionally required		price on request
----------------	---	--	---------------------

te 2010	rail connection with aligning connection		
----------------	--	--	--

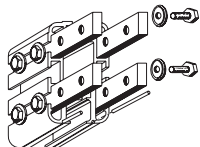

weight 0.8 kg set 72.00





te 2119-2	end stop and buffer, weight 28 g	pc	5.25
------------------	----------------------------------	----	------

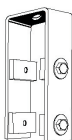

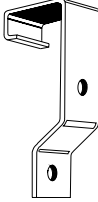
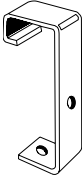

te 2071	universal safety suspension mounting bracket incl. 4 sliding blocks te 2081 and 4 screws M 10 x 18 with washers, weight 0.89 kg	set	34.00
----------------	--	-----	-------

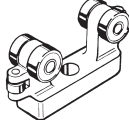

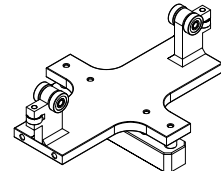

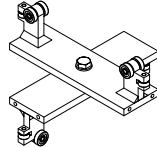

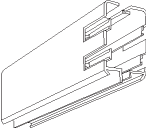
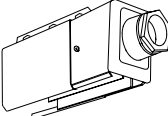
te 2075	universal safety wall attachment incl. 2 sliding blocks te 2085 and 4 screws M 10 x 18 with washers, weight 1.04 kg	set	38.00
----------------	--	-----	-------

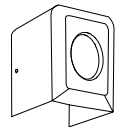
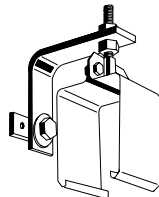
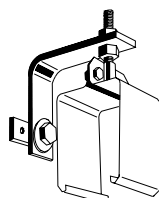
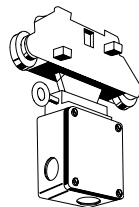
Item	Definition	Unit	Euro
te 2072	safety suspension mounting bracket with drilled hole 10 mm diam., weight 0.45 kg	set	29.00
			
te 2073	safety suspension mounting bracket, 90° offset with drilled hole 10 mm diam., weight 0.49 kg	set	29.00
			
te 2080	sliding block with threaded hole M 10 and positioning pin M5, weight 45 g	pc	3.80
			
te 2085	sliding block, 75 mm length with 2 threaded holes M 10, weight 95 g	pc	6.00
			
te 2155-2	aluminium trolley with vertical hole 10 mm diam. carrying capacity 750 N, weight 0.125 kg	pc	59.00
			
te 2158	ring nut M 10 for trolley te 2155 with screw M 10 x 35 and counter nut, weight 0.13 kg	pc	3.55
			
te 2160-2	travelling stage carriage, rigid 1,500 N carrying capacity, weight 2.1 kg	pc	185.00
			

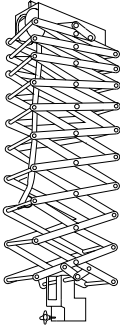
Item	Definition	Unit	Euro
te 2170-2	travelling stage carriage diagonally adjustable 1,500 N carrying capacity, weight 2.5 kg as traveling stage)	pc	265.00
			
te 2114	mini runner, plastic, on ball bearings black, 100 N carrying capacity, weight 14g	pc	5.80
			
te 2115	cable carrier to hook into the mini runner for 1-3 cables, weight 32 g	pc	4.40
			
te 4001	plastic electric cable safetydesign, 5-pins standard length 4,5 m maximale load 5 x 60 A weight 1,75 kg	m	69.00
			
te 4010	bush connection 5 x 60 A, weight 0,42 kg	pc	33.00
te 4012	supply unit, maximal load up to 5 x 60 A weight 0,83 kg	pc	148.00
			

Item	Definition	Unit	Euro
te 4015	sealing end for te 4001, weight 0,14 kg	pc	17.50
			
te 4016	fixed-point suspension assembly kit incl. weight 0,45 kg (1 pc per installation required)	set	26.50
			
te 4018	sliding suspension, assembly kit incl. weight 0,54 kg (suspension distance ca. 1,50 m)	set	26.50
			
te 4060	power pick-up carriage safety design with 5-pin distributor, max. load up to 5 x 40 A carrier incl., weight 0,89 kg (installation on request)	pc	215.00
			

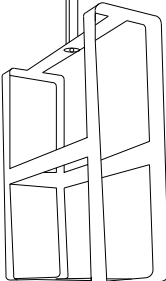
Item	Definition	Unit	Euro
te 2521 te 2522	 <p data-bbox="342 181 773 316">pantograph with 1 spring, 360° rotatable up to 180 N carrying capacity connector for lamp adapter 16 mm diam. weight 7.2 kg, trolley incl.</p>	pc	615.00
		pc	855.00
te 2555	 <p data-bbox="371 558 773 654">lamp adapter 28 mm diam. for spring pantograph with threaded bolt M 10, weight 0.6 kg</p>	pc	25.00
te 2556	dito 28 mm diam. x 5/8" diam., weight 0.6 kg	pc	44.00
te 2525	 <p data-bbox="297 762 773 826">lamp adapter 5/8" x 5/8" diam. for pantograph weight 0.1 kg</p>	pc	13.00
te 2606	 <p data-bbox="360 871 773 967">telescopic suspension for generator box adjustable from 1,100 - 1,900 mm box 360 ° turnable, weight 2,5 kg</p>	pc	145.00
te 2607	 <p data-bbox="371 1066 773 1129">dito adjustable from 2,100 - 3,900 mm weight 4.7 kg</p>	pc	185.00
te 2601	<p data-bbox="331 1241 773 1305">generator box for 1 ELINCHROM genrator weight 4.6 kg</p>	pc	190.00
te 2614-4	<p data-bbox="360 1347 773 1474">dito for BRONCOLOR Grafit 4 generator generator box for generators from other manufacturers</p>	pc	245.00 price on request

Item	Definition	Unit	Euro
te 2620	tension spring 1,600 mm outstretched carrying capacity 5 - 9 N adjustable weight 1.0 kg	pc	78.00
te 2621	carrying capacity 9 - 18 N adjustable weight 1.0 kg	pc	92.00
te 2622	tension spring 2,000 mm outstretched with automatic locking device carrying capacity 20 - 30 N adjustable weight 2.0 kg	pc	138.00
te 2704 te 2705 te 2706 te 2707	motor-ceiling-telescope carrying capacity up to 400 N, connector for lamp adapter 5/8", trolley incl., operating range (from bottom edge travelling stage) 555 - 2,555 mm, weight 14.8 kg 655 - 3,255 mm, weight 16.2 kg 755 - 3,955 mm, weight 17.6 kg 855 - 4,655 mm, weight 19.0 kg	pc pc pc pc	1975.00 2075.00 2175.00 2275.00

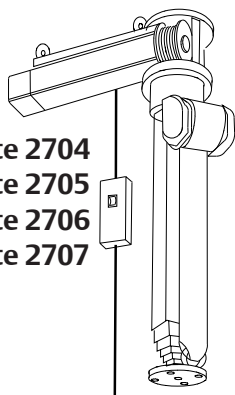
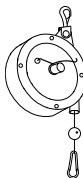
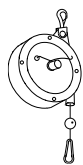

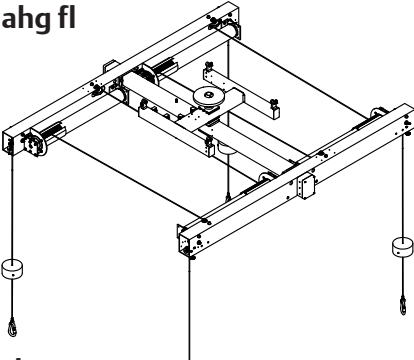
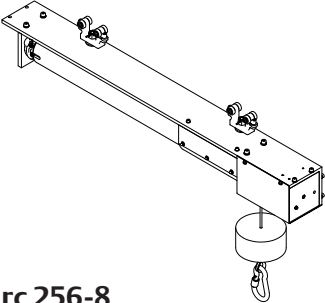
Item	Definition	Unit	Euro
ahg fl	four point suspension	pc	5860.00
			
shz 125	motor winch, 1250 N carrying capacity trolleys incl.	pc	1680.00
			
rc 256-8	radio control unit 8 channels compl. with transmitter, receiver power output element	pc	1560.00
rc 256-16	radio control unit 16 channels compl. with transmitter, receiver power output element	pc	1780.00

COMPACT CEILING TRACK SYSTEM

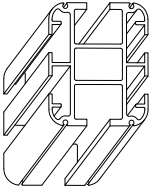
te 3008-4 te 3008-5 te 3008-6		Compact-ceiling rail aluminium black anodized, weight 3.2 kg/m		
		standard length 4 m	m	163.00
		standard length 5 m	m	205.00
		standard length 6 m	m	245.00

te 2010 rail connection with aligning connection

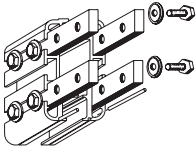

weight 0.8 kg set 72.00

te 2119-2

end stop and buffer, weight 28 g pc 5.25



te 2076

universal safety suspension mounting bracket
incl. 2 sliding blocks
te 2081 and 2 screws M 10 x 18
with washers, weight 0.89 kg

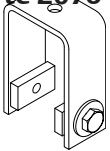

set 24.00

te 2130

travelling stage carriage diagonally adjustable
750 N carrying capacity, weight 0.5 kg

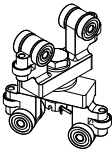

pc 95.00

Item	Definition	Unit	Euro
------	------------	------	------

curtain tracks

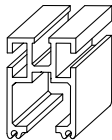
te 2022 te 2023		curtain track, standard length 6 m		
		aluminium bright drawn	m	27.00
		aluminium black anodized	m	33.00
te 2025		standard arc 90°, R = 500 mm		
		aluminium bright drawn	pc	295.00
		aluminium black anodized	pc	on request
te 2114 5.40		curtain roller, plastic, black with ball bearings, 100 N carrying capacity	pc	
te 2029 0.85		S-hook, for mini runner	pc	
te 2026		connector for curtain track	pc	22.80
te 2119 4.75		end stop for curtain track	pc	

time-master

tm 72000	time-master, basic unit with synchro cord length 5 m and plug in power supply	pc	660.00
tm 72020	acoustic trigger attachment for time-master	pc	145.00
tm 72030	light barrier trigger attachment	pc	425.00

